

Article number: 51030540000010

Description: Vibration damper GS-M2
150x75x2000-15, NR shore 57

Measures

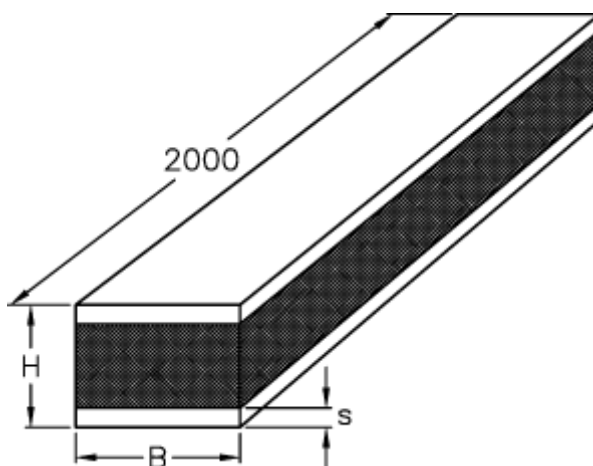

B = 150

H = 75

S = 15